

CE EMC Test Report (EN 50155 & EN 50121-3-2)

Report No.: CE190611D10-1

Test Model: SE-1004

Series Model: SE-1XXXXXXXXXXXXXXXXXX ("X" can be 0-9, A-Z or blank for marketing purpose)

Received Date: Jun. 11, 2019

Test Date: Jun. 17 to Aug. 24, 2019

Issued Date: Aug. 28, 2019

Applicant: Vecow Co., Ltd.

Address: 3F., No.10, Jiankang Rd., Zhonghe Dist., New Taipei City 23586, Taiwan

Issued By: Bureau Veritas Consumer Products Services (H.K.) Ltd., Taoyuan Branch
Lin Kou Laboratories

Lab Address: No. 47-2, 14th Ling, Chia Pau Vil., Lin Kou Dist., New Taipei City, Taiwan

Test Location (1): No. 47-2, 14th Ling, Chia Pau Vil., Lin Kou Dist., New Taipei City, Taiwan

Test Location (2): No. 19, Hwa Ya 2nd Rd., Wen Hwa Vil., Kwei Shan Dist., Taoyuan City
33383, Taiwan



This report is for your exclusive use. Any copying or replication of this report to or for any other person or entity, or use of our name or trademark, is permitted only with our prior written permission. This report sets forth our findings solely with respect to the test samples identified herein. The results set forth in this report are not indicative or representative of the quality or characteristics of the lot from which a test sample was taken or any similar or identical product unless specifically and expressly noted. Our report includes all of the tests requested by you and the results thereof based upon the information that you provided to us. You have 60 days from date of issuance of this report to notify us of any material error or omission caused by our negligence, provided, however, that such notice shall be in writing and shall specifically address the issue you wish to raise. A failure to raise such issue within the prescribed time shall constitute your unqualified acceptance of the completeness of this report, the tests conducted and the correctness of the report contents. Unless specific mention, the uncertainty of measurement has been explicitly taken into account to declare the compliance or non-compliance to the specification. The report must not be used by the client to claim product certification, approval, or endorsement by TAF or any government agencies.

Table of Contents

Release Control Record	4
1 Certificate of Conformity	5
2 Summary of Test Results	6
2.1 Performance Criteria	8
2.2 Measurement Uncertainty	8
2.3 Modification Record.....	8
3 General Information	9
3.1 Description of EUT	9
3.2 Features of EUT	9
3.3 Operating Modes of EUT and Determination of Worst Case Operating Mode	10
3.4 Test Program Used and Operation Descriptions.....	11
3.5 Primary Clock Frequencies of Internal Source	11
4 Configuration and Connections with EUT	12
4.1 Connection Diagram of EUT and Peripheral Devices.....	12
4.2 Configuration of Peripheral Devices and Cable Connections	14
5 Conducted Disturbance at Auxiliary a.c. or d.c. Power Ports	16
5.1 Limits	16
5.2 Test Instruments	16
5.3 Test Arrangement	17
5.4 Test Results	18
6 Radiated Disturbance up to 1 GHz	20
6.1 Limits	20
6.2 Test Instruments	20
6.3 Test Arrangement	21
6.4 Test Results	22
7 Radiated Disturbance above 1 GHz	24
7.1 Limits	24
7.2 Test Instruments	25
7.3 Test Arrangement	26
7.4 Test Results	27
8 Electrostatic Discharge Immunity Test (ESD)	29
8.1 Test Specification.....	29
8.2 Test Instruments	29
8.3 Test Arrangement	30
8.4 Test Results	31
9 Radio-frequency Electromagnetic Field Immunity Test (RS)	33
9.1 Test Specification.....	33
9.2 Test Instruments	33
9.3 Test Arrangement	34
9.4 Test Results	35
10 Electrical Fast Transient/Burst Immunity Test (EFT)	36
10.1 Test Specification.....	36
10.2 Test Instruments	36
10.3 Test Arrangement	37
10.4 Test Results	38

11	Immunity to Conducted Disturbances Induced by RF Fields (CS)	39
11.1	Test Specification.....	39
11.2	Test Instruments	39
11.3	Test Arrangement	40
11.4	Test Results	41
12	Pictures of Test Arrangements	42
12.1	Conducted Disturbance at Auxiliary a.c. or d.c. power ports	42
12.2	Radiated Disturbance up to 1 GHz	43
12.3	Radiated Disturbance above 1 GHz.....	44
12.4	Electrostatic Discharge Immunity Test (ESD)	45
12.5	Radio-frequency Electromagnetic Field Immunity Test (RS)	46
12.6	Fast Transients (EFT).....	47
12.7	Radio-frequency common mode (CS).....	47
	Appendix – Information of the Testing Laboratories	48

Release Control Record

Issue No.	Description	Date Issued
CE190611D10-1	Original release.	Aug. 28, 2019

2 Summary of Test Results

EN 50121-3-2:2016, Emission requirements, EN 50155:2017, Clause 13.4.8			
Port	Test Item / specifications	Result/Remarks	Verdict
Auxiliary a.c. or d.c. power ports - Auxiliary supply sinusoidal a.c. or d.c.	Conducted disturbance 150 kHz- 500 kHz: 99 dB μ V quasi-peak 500 kHz- 30 MHz: 93 dB μ V quasi-peak	Minimum passing margin is -39.88 dB at 13.55860 MHz	Pass
Auxiliary a.c. or d.c. power ports – AC power outlet port for public use	Conducted disturbance 50 Hz- 2 kHz: THD <8% (THD: total harmonic distortion)	Test not applicable because the port does not exist.	N/A
Battery referenced ports - Battery power supply	Conducted disturbance 150 kHz- 500 kHz: 99 dB μ V quasi-peak 500 kHz- 30 MHz: 93 dB μ V quasi-peak	Test not applicable because the port does not exist.	N/A
Enclosure	Radiated disturbance 30 MHz- 230 MHz: 40 dB μ V/m quasi-peak 230 MHz -1 GHz: 47 dB μ V/m quasi-peak	Minimum passing margin is -4.66 dB at 141.72 MHz	Pass
Enclosure	Radiated disturbance 1 GHz- 3 GHz: 76 dB μ V/m peak 56 dB μ V/m average 3 GHz - 6 GHz: 80 dB μ V/m peak 60 dB μ V/m average	Minimum passing margin is -3.11 dB at 1000.08 MHz	Pass

EN 50121-3-2:2016, Immunity requirements, EN 50155:2017, Clause 13.4.8					
Table Clause	Basic standard	Port	Test Item / specifications	Result/Remarks	Verdict
3.1	EN 61000-4-6:2014 +AC:2015	Battery referenced ports (except at the output of energy sources), Auxiliary a.c. power input ports (rated voltage \leq 400 Vrms)	Radio-frequency common mode (CS) 80% AM (1kHz) 0.15-80 MHz, 10V Performance Criterion A	Test not applicable because port does not exist	N/A
3.2	EN 61000-4-4:2012	Battery referenced ports (except at the output of energy sources), Auxiliary a.c. power input ports (rated voltage \leq 400 Vrms)	Fast Transients (EFT) 5/50 (T_r/T_h) ns, 5kHz \pm 2kV Performance Criterion A	Test not applicable because port does not exist	N/A
3.3	EN 61000-4-5:2014 +A1:2017	Battery referenced ports (except at the output of energy sources), Auxiliary a.c. power input ports (rated voltage \leq 400 Vrms)	Surges 1.2/50 (8/20) (T_r/T_h) μ s Line to ground: \pm 2kV 42 Ω , 0.5 μ F Line to line: \pm 1kV 42 Ω , 0.5 μ F Performance Criterion B	Test not applicable because port does not exist	N/A

EN 50121-3-2:2016, Immunity requirements, EN 50155:2017, Clause 13.4.8					
Table Clause	Basic standard	Port	Test Item / specifications	Result/Remarks	Verdict
4.1	EN 61000-4-6:2014 +AC:2015	Signal & communication, process measurement & control ports	Radio-frequency common mode (CS) 80% AM (1kHz) 0.15-80 MHz, 10V Performance Criterion A	Performance Criterion A	Pass
4.2	EN 61000-4-4:2012	Signal & communication, process measurement & control ports	Fast Transients (EFT) 5/50 (T _r /T _f) ns, 5kHz ±2kV, Capacitive clamp Performance Criterion A	Performance Criterion A	Pass
5.1	EN 61000-4-3:2006 +A1:2008 +A2:2010	Enclosure ports	Radio-frequency electromagnetic field amplitude modulated (RS) ¹ , 80% AM (1kHz) 80-800 MHz, 20V/m Performance Criterion A	Performance Criterion A	Pass
5.2	EN 61000-4-3:2006 +A1:2008 +A2:2010	Enclosure ports	Radio-frequency electromagnetic field from digital mobile telephones (RS) ² , 80% AM (1kHz) 800-1000 MHz, 20V/m 1400-2000 MHz, 10V/m 2000-2700 MHz, 5V/m 5100-6000 MHz, 3V/m Performance Criterion A	Performance Criterion A	Pass
5.3	EN 61000-4-2:2009	Enclosure ports	Electrostatic Discharges (ESD) ±6kV Contact discharge ±8kV Air discharge Performance Criterion B	Performance Criterion A	Pass

Note 1: This limit applies to equipment mounted in the passenger compartments, drivers cab or external to the rolling stock (roof, underframe). For equipment mounted in all other areas a severity level of 10 V/m may be used.

Note 2: For large apparatus (e.g. traction drives, auxiliary converters) it is often not practical to perform the immunity test to radiated electromagnetic fields on the complete unit. In such cases the manufacturer should test susceptible sub-systems (e.g. control electronics). The test report should justify the selection or not of sub-systems and any assumptions made (e.g. reduction of field due to case shielding).

Note:

1. There is no deviation to the applied test methods and requirements covered by the scope of this report.
2. The above EN basic standards are applied with latest version if customer has no special requirement.
3. Determining compliance based on the results of the compliance measurement, not taking into account measurement instrumentation uncertainty.
4. N/A: Not Applicable

2.1 Performance Criteria

General Performance Criteria

The general performance criteria apply for those ports for which no specific performance criteria are defined (e.g. auxiliary ports) in the report.

Performance criterion A: The apparatus shall continue to operate as intended during and after the test. No degradation of performance or loss of function is allowed below a performance level specified by the manufacturer, when the apparatus is used as intended. The performance level may be replaced by a permissible loss of performance. If the minimum performance level or the permissible performance loss is not specified by the manufacturer, either of these may be derived from the product description and documentation, and from what the user may reasonably expect from the apparatus if used as intended..

Performance criterion B: The apparatus shall continue to operate as intended after the test. No degradation of performance or loss of function is allowed below a performance level specified by the manufacturer, when the apparatus is used as intended. The performance level may be replaced by a permissible loss of performance. During the test, degradation of performance is however allowed. No change of actual operating state or stored data is allowed. If the minimum performance level or the permissible performance loss is not specified by the manufacturer, either of these may be derived from the product description and documentation, and from what the user may reasonably expect from the apparatus if used as intended.

Performance criterion C: Temporary loss of function is allowed, provided the function is selfrecoverable or can be restored by the operation of the controls.

2.2 Measurement Uncertainty

Where relevant, the following measurement uncertainty levels have been estimated for tests performed on the EUT as specified in CISPR 16-4-2:

Measurement	Expanded Uncertainty (k=2) (\pm)	Maximum allowable uncertainty (\pm)
Conducted disturbance at mains port using AMN, 150kHz ~ 30MHz	2.77 dB	3.4 dB (U_{CISPR})
Radiated disturbance, 30MHz ~ 1GHz	4.01 dB	6.3 dB (U_{CISPR})
Radiated disturbance, 1GHz ~ 6GHz	5.21 dB	5.2 dB (U_{CISPR})

The other instruments specified are routine verified to remain within the calibrated levels, no measurement uncertainty is required to be calculated.

2.3 Modification Record

There were no modifications required for compliance.

3 General Information

3.1 Description of EUT

Product	PCI Express LAN Switch/PoE+ Expansion Card
Brand	Vecow
Test Model	SE-1004
Series Model	SE-1XXXXXXXXXXXXXXXXX ("X" can be 0-9, A-Z or blank for marketing purpose)
Model Difference	Marketing Purpose
Sample Status	Engineering sample
Operating Software	N/A
Power Supply Rating	DC power from IPC
Accessory Device	N/A
Data Cable Supplied	N/A

Note:

1. The EUT is a PCI Express LAN Switch/PoE+ Expansion Card with four LAN ports.
2. The EUT maximum data rate is 1Gbps.

3.2 Features of EUT

The tests reported herein were performed according to the method specified by Vecow Co., Ltd., for detailed feature description, please refer to the manufacturer's specifications or user's manual.

3.3 Operating Modes of EUT and Determination of Worst Case Operating Mode

1. The EUT is consumes power from PC which designed with AC power of rating 100-240Vac, 50/60Hz. For radiated emission evaluation, 230Vac/50Hz (EN 50121-3-2), 120Vac/60Hz (for FCC Part 15) had been covered during the pre-test. The worst data was found at **230Vac/50Hz** and recorded in the applied test report.
2. Test modes are presented in the report as below.

Mode	Test Condition	Input Power
Conducted emission test		
1	EUT installed in IPC+ *IP Camera (100Mbps)	230Vac/ 50Hz (System)
Radiated emission test		
1	EUT installed in IPC + *IP Camera (100Mbps)	230Vac/ 50Hz (System)
Immunity tests (RS test excluded)		
1	EUT installed in IPC+ *IP Camera (100Mbps)	230Vac/ 50Hz (System)
RS test		
1	EUT installed in IPC+ *IP Camera (100Mbps)	24Vdc

Note*: As client's request, using the maximum data rate of IP camera (Supplied by client) is 100Mbps during the test.

3.4 Test Program Used and Operation Descriptions

Emission tests:

- a. Installed the EUT into IPC.
- b. Turned on the power of all equipment.
- c. IPC ran a test program to enable all functions.
- d. IPC read and wrote messages from/to HDD.
- e. IP camera ping IPC via EUT with four UTP LAN cables.
- f. IPC sent "H" messages to monitor then displayed these messages on its screen.
- g. IPC sent messages to printer and printer printed them out.
- h. IPC sent messages to modem.
- i. Steps d-h were repeated.

Immunity tests (RS test excluded):

- a. Installed the EUT into IPC.
- b. Turned on the power of all equipment.
- c. IPC ran a test program to enable all functions.
- d. IPC read and wrote messages from/to HDD.
- e. IP camera ping IPC via EUT with four UTP LAN cables.
- f. IPC sent "H" messages to monitor then displayed "H" messages on its screen.
- g. Steps d- f were repeated.

Immunity tests (Only for RS test):

- a. Installed the EUT into IPC.
- b. Turned on the power of all equipment.
- c. IPC ran a test program to enable all functions.
- d. IPC read and wrote messages from/to HDD.
- e. IP camera (kept in a remote area) ping IPC via EUT with four UTP LAN cables.
- f. IPC sent "H" messages to monitor (kept in a remote area) then displayed "H" messages on its screen.
- g. Steps d-f were repeated.

3.5 Primary Clock Frequencies of Internal Source

The highest frequency generated or used within the EUT or on which the EUT operates or tunes is 1000 MHz, provided by Vecow Co., Ltd., for detailed internal source, please refer to the manufacturer's specifications.

4 Configuration and Connections with EUT

4.1 Connection Diagram of EUT and Peripheral Devices

Emission tests:

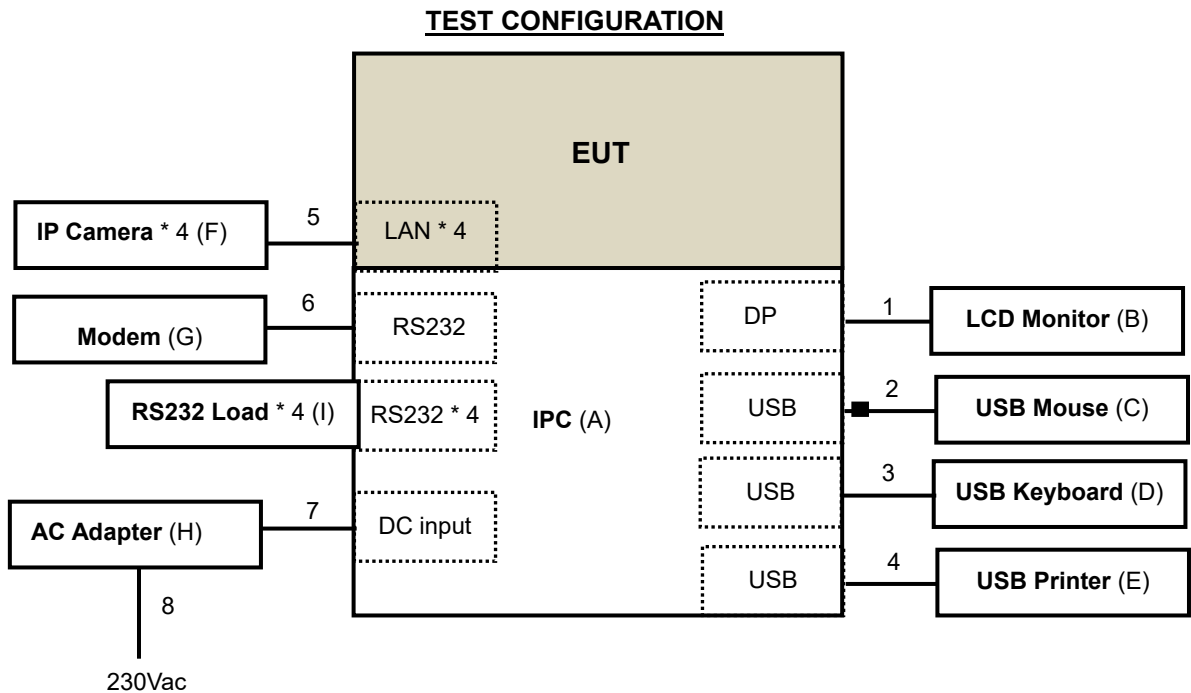

Immunity tests (RS test excluded):

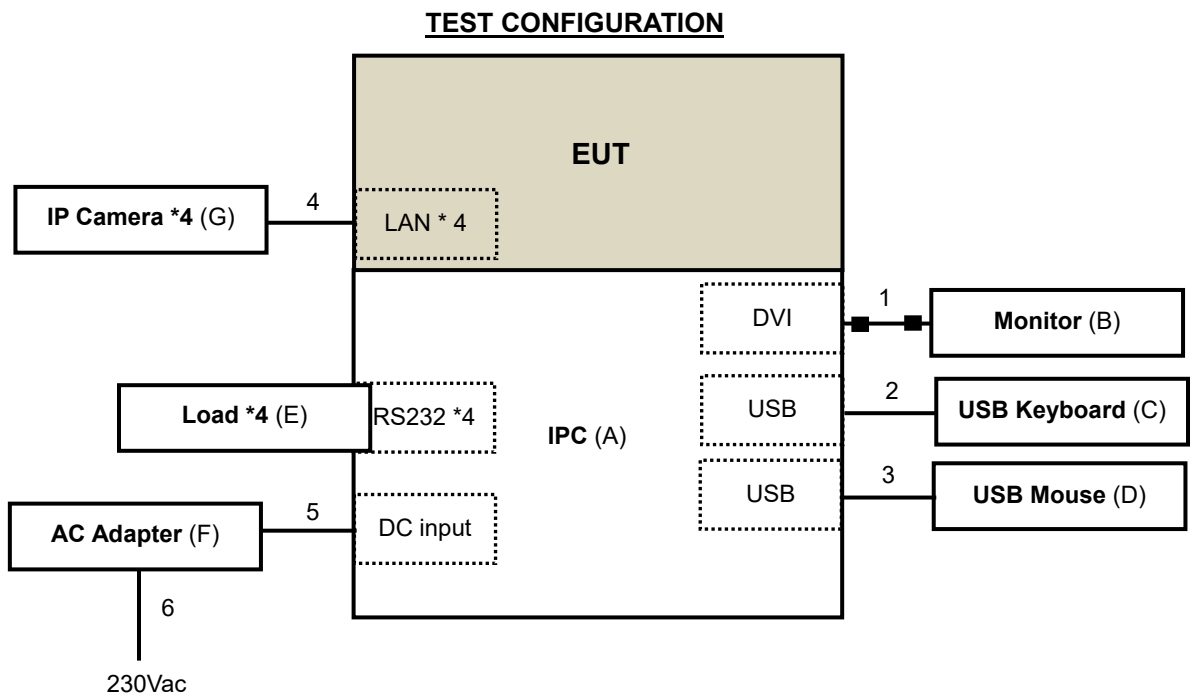

Immunity tests (Only for RS test):

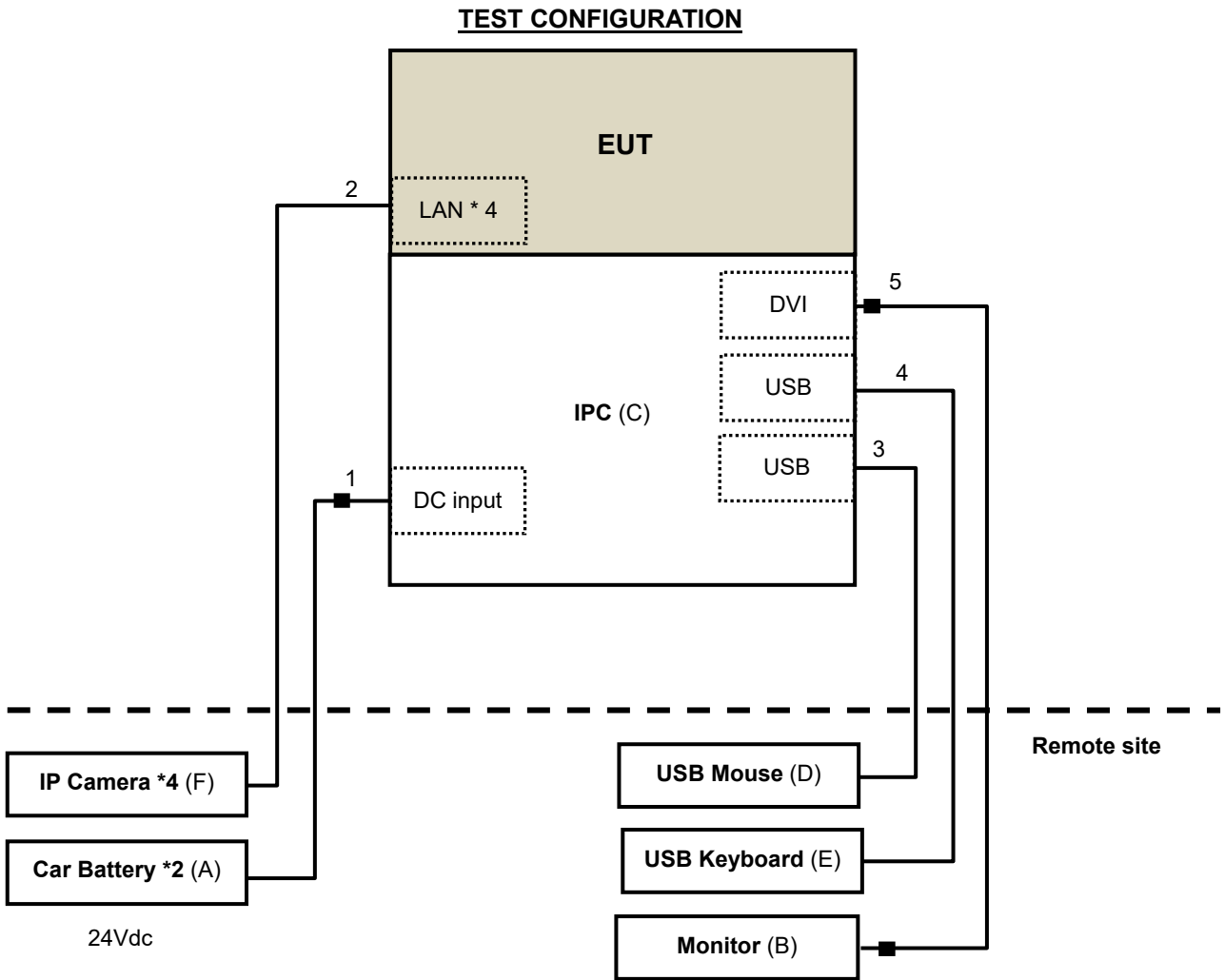

4.2 Configuration of Peripheral Devices and Cable Connections

Emission tests:

ID	Product	Brand	Model No.	Serial No.	FCC ID	Remarks
A.	IPC	Vecow	RCS-9000	N/A	N/A	Supplied by client
B.	LCD Monitor	ASUS	MG28UQ	J1LMTF114786	N/A	Provided by Lab
C.	USB Mouse	Microsoft	1113	9170528318292	FCC DoC Approved	Provided by Lab
D.	USB KEYBOARD	Dell	KB216t	CN-0W33XP-LO300-7CL-1908	FCC DoC Approved	Provided by Lab
E.	Printer	HP	Officejet pro 251dw	N/A	N/A	Provided by Lab
F.	IP Camera*4	N/A	A301RZ-0309P	WXF1E84H2ASN	FCC DoC Approved	Supplied by client
G.	Modem	ACEEX	1414	0206026747	IFAXDM1414	Provided by Lab
H.	Adapter	Seasonic	SSA-1201-24	N/A	N/A	Supplied by client
I.	RS232 Load*4	N/A	N/A	N/A	N/A	Supplied by client

Note:

- All power cords of the above support units are non-shielded (1.8m).
- The rating of support unit H is as follows:

AC I/P: 100-240Vac, 2A, 50/60Hz

DC O/P: 24V/5A, 120W Max

ID	Descriptions	Qty.	Length (m)	Shielding (Yes/No)	Cores (Qty.)	Remarks
1.	DP cable	1	1.8	Y	0	Provided by Lab
2.	USB cable	1	1.8	Y	1	Provided by Lab
3.	USB cable	1	1.8	Y	0	Provided by Lab
4.	USB cable	1	1.5	Y	0	Provided by Lab
5.	LAN cable (Cat.5e)	4	10	N	0	Provided by Lab
6.	RS232 cable	1	1.5	Y	0	Provided by Lab
7.	DC power	1	1.0	N	0	Supplied by client
8.	AC power cord	1	1.8	N	0	Provided by Lab

Note: The core(s) is(are) originally attached to the cable(s).

Immunity tests (RS test excluded):

ID	Product	Brand	Model No.	Serial No.	FCC ID	Remarks
A.	IPC	Vecow	RCS-9000	N/A	N/A	Supplied by client
B.	24" LCD Monitor	DELL	U2410	CN082WXD728720 CC0KDL	N/A	Provided by Lab
C.	USB Keyboard	LENOVO	KB1021	N/A	FCC DoC Approved	Provided by Lab
D.	USB Mouse	LENOVO	SM-8823	N/A	FCC DoC Approved	Provided by Lab
E.	Load*4	N/A	N/A	N/A	N/A	Provided by Lab
F.	Adapter	Seasonic	SSA-1201-24	N/A	N/A	Supplied by client
G.	IP Camera *4	N/A	A301RZ-0309P	WXF1E84H2ASN	FCC DoC Approved	Supplied by client

Note:

- All power cords of the above support units are non-shielded (1.8m).
- The rating of support unit F is as follows:
 AC I/P: 100-240Vac, 2A, 50/60Hz
 DC O/P: 24V/5A, 120W Max

ID	Descriptions	Qty.	Length (m)	Shielding (Yes/No)	Cores (Qty.)	Remarks
1.	DVI cable	1	1.8	Y	2	Provided by Lab
2.	USB cable	1	1.8	Y	0	Provided by Lab
3.	USB cable	1	1.8	Y	0	Provided by Lab
4.	LAN cable (Cat.5e)	4	5.0	N	0	Provided by Lab
5.	DC cable	1	1.0	N	0	Supplied by client
6.	AC power cable	1	1.8	N	0	Provided by Lab

Note: The core(s) is(are) originally attached to the cable(s).

Immunity tests (Only for RS test):

ID	Product	Brand	Model No.	Serial No.	FCC ID	Remarks
A.	Car Battery *2	YUASA	75D23R	N/A	N/A	Provided by Lab
B.	24" LCD Monitor	DELL	2408FPb	CN-0G293H-74261- 874-22KS-A00	N/A	Provided by Lab
C.	IPC	Vecow	RCS-9000	N/A	N/A	Supplied by client
D.	USB Mouse	Dell	MS111-L	N/A	FCC DoC Approved	Provided by Lab
E.	USB Keyboard	Dell	SK-8115	N/A	FCC DoC Approved	Provided by Lab
F.	IP Camera *4	N/A	A301RZ-0309P	WXF1E84H2ASN	FCC DoC Approved	Supplied by client

Note: All power cords of the above support units are non-shielded (1.8m).

ID	Descriptions	Qty.	Length (m)	Shielding (Yes/No)	Cores (Qty.)	Remarks
1.	DC power cable	1	5.0	N	1	Provided by Lab
2.	LAN cable (Cat.5e)	4	5.0	N	0	Provided by Lab
3.	USB cable	1	1.8	Y	0	Provided by Lab
4.	USB cable	1	2.0	Y	0	Provided by Lab
5.	DVI cable	1	1.5	Y	2	Provided by Lab

Note: The core(s) is(are) originally attached to the cable(s).

5 Conducted Disturbance at Auxiliary a.c. or d.c. Power Ports

5.1 Limits

Frequency (MHz)	Quasi-peak, (dBuV)
0.15 - 0.5	99
0.5 - 30	93

Notes: 1. The lower limit shall apply at the transition frequencies.
 2. The limit decreases linearly with the logarithm of the frequency in the range of 0.15 to 0.50 MHz.

5.2 Test Instruments

Description & Manufacturer	Model No.	Serial No.	Cal. Date	Cal. Due
ROHDE & SCHWARZ TEST RECEIVER	ESCS 30	838251/021	Nov. 1, 2018	Oct. 31, 2019
ROHDE & SCHWARZ Artificial Mains Network (For EUT)	ENV216	101195	May 9, 2019	May 8, 2020
LISN With Adapter(for EUT)	101195	N/A	May 9, 2019	May 8, 2020
EMCO L.I.S.N. (For peripherals)	3825/2	9504-2359	Jul. 26, 2018	Jul. 25, 2019
SCHWARZBECK Artificial Mains Network (For EUT)	NNLK8129	8129229	May 14, 2019	May 13, 2020
SCHWARZBECK Artificial Mains Network (For EUT)	NNLK 8121	8121-808	Mar. 15, 2019	Mar. 14, 2020
Software	Cond_V7.3.7.4	NA	NA	NA
RF cable (JYEBAO) With 10dB PAD	5D-FB	Cable-C03-01	Sep. 18, 2018	Sep. 17, 2019
LYNICS Terminator (For EMCO LISN)	0900510	E1-01-300	Jan. 25, 2019	Jan. 24, 2020
LYNICS Terminator (For EMCO LISN)	0900510	E1-01-301	Jan. 25, 2019	Jan. 24, 2020
ROHDE & SCHWARZ Artificial Mains Network (For TV EUT)	ESH3-Z5	100220	Nov. 21, 2018	Nov. 20, 2019
LISN With Adapter(for TV EUT)	100220	NA	Nov. 21, 2018	Nov. 20, 2019

Note: 1. The calibration interval of the above test instruments is 12 months and the calibrations are traceable to NML/ROC and NIST/USA.
 2. The test was performed in Shielded Room No. 3.
 3. The VCCI Site Registration No. C-10274.
 4. Tested Date: Jun. 17, 2019

5.3 Test Arrangement

- The EUT was placed 0.4 meters from the conducting wall of the shielded room with EUT being connected to the power mains through a line impedance stabilization network (LISN). Other support units were connected to the power mains through another LISN. The two LISNs provide 50 Ohm/ 50uH of coupling impedance for the measuring instrument.
- Both lines of the power mains connected to the EUT were checked for maximum conducted interference.
- The test results of conducted emissions at mains ports are recorded of six worst margins for quasi-peak (mandatory) [and average (if necessary)] values against the limits at frequencies of interest unless the margin is 20 dB or greater.

Note: The resolution bandwidth and video bandwidth of test receiver is 9kHz for quasi-peak detection (QP) and average detection (AV) at frequency 0.15MHz-30MHz.

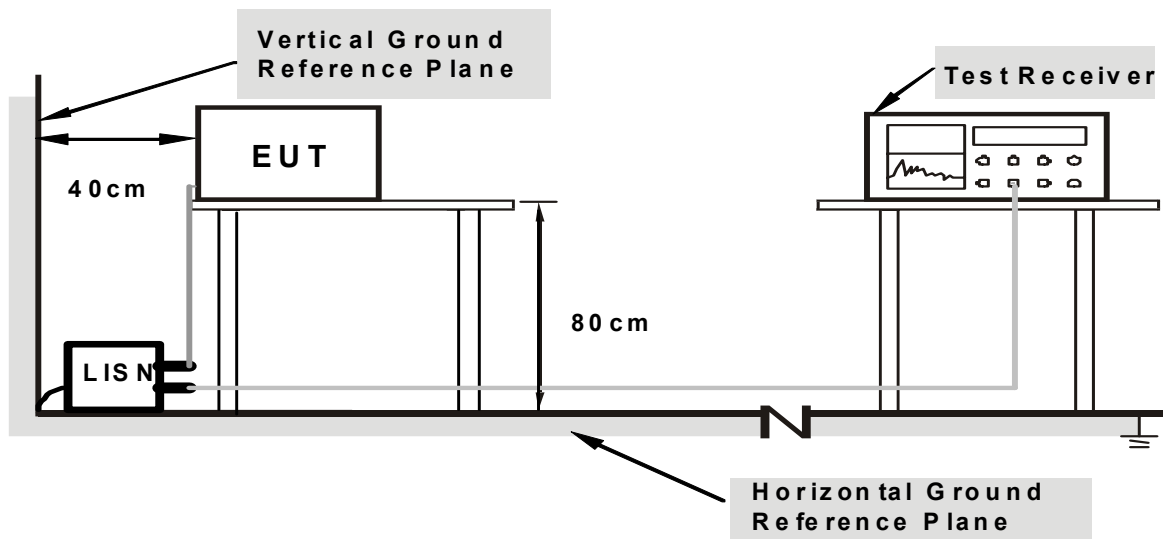

Note: Support units were connected to second LISN.

For the actual test configuration, please refer to the related item – Photographs of the Test Configuration.

5.4 Test Results

Frequency Range	150kHz ~ 30MHz	Detector Function & Bandwidth	Quasi-Peak (QP) / Average (AV), 9kHz
Input Power (System)	230Vac, 50Hz	Environmental Conditions	25°C, 71%RH
Tested by	John Liao		
Test Mode	Mode 1		

Phase Of Power : Line (L)						
No	Frequency (MHz)	Correction Factor (dB)	Reading Value (dBuV)	Emission Level (dBuV)	Limit (dBuV)	Margin (dB)
			Q.P.	Q.P.	Q.P.	Q.P.
1	0.19297	9.61	35.55	45.16	99.00	-53.84
2	0.44688	9.63	28.80	38.43	99.00	-60.57
3	13.55860	9.89	43.23	53.12	93.00	-39.88
4	14.76172	9.90	40.60	50.50	93.00	-42.50
5	18.30469	9.92	36.62	46.54	93.00	-46.46
6	23.96484	9.94	30.49	40.43	93.00	-52.57

Remarks:

1. Q.P. and AV. are abbreviations of quasi-peak and average individually.
2. The emission levels of other frequencies were very low against the limit.
3. Margin value = Emission level – Limit value
4. Correction factor = Insertion loss + Cable loss
5. Emission Level = Correction Factor + Reading Value

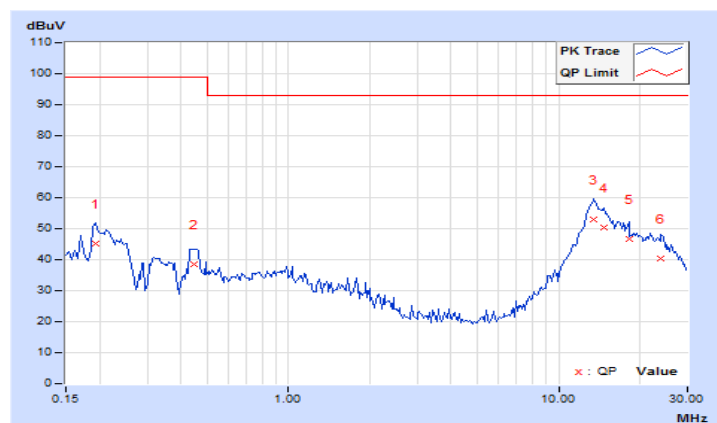

Frequency Range	150kHz ~ 30MHz	Detector Function & Bandwidth	Quasi-Peak (QP) / Average (AV), 9kHz
Input Power (System)	230Vac, 50Hz	Environmental Conditions	25°C, 71%RH
Tested by	John Liao		
Test Mode	Mode 1		

Phase Of Power : Neutral (N)						
No	Frequency (MHz)	Correction Factor (dB)	Reading Value (dBuV)	Emission Level (dBuV)	Limit (dBuV)	Margin (dB)
			Q.P.	Q.P.	Q.P.	Q.P.
1	0.18125	9.60	36.75	46.35	99.00	-52.65
2	0.43906	9.61	25.57	35.18	99.00	-63.82
3	1.02344	9.66	23.64	33.30	93.00	-59.70
4	13.53125	9.91	43.20	53.11	93.00	-39.89
5	14.01938	9.91	42.67	52.58	93.00	-40.42
6	20.44141	9.97	31.94	41.91	93.00	-51.09

Remarks:

1. Q.P. and AV. are abbreviations of quasi-peak and average individually.
2. The emission levels of other frequencies were very low against the limit.
3. Margin value = Emission level – Limit value
4. Correction factor = Insertion loss + Cable loss
5. Emission Level = Correction Factor + Reading Value

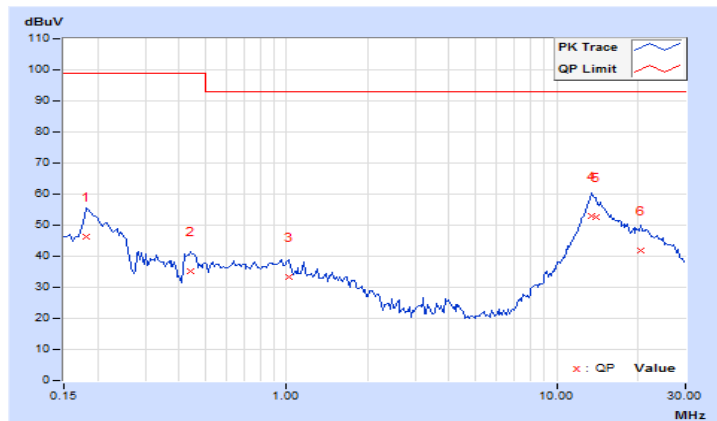

6 Radiated Disturbance up to 1 GHz

6.1 Limits

Frequency (MHz)	dBuV/m (at 10m) / quasi-peak
30 - 230	40
230 - 1000	47

- Notes:
1. The lower limit shall apply at the transition frequencies.
 2. Emission level (dBuV/m) = 20 log Emission level (uV/m).
 3. All emanations from a class A/B digital device or system, including any network of conductors and apparatus connected thereto, shall not exceed the level of field strengths specified above.

6.2 Test Instruments

Description & Manufacturer	Model No.	Serial No.	Cal. Date	Cal. Due
ROHDE & SCHWARZ TEST RECEIVER	ESCI	100612	Nov. 26, 2018	Nov. 25, 2019
SCHAFFNER BILOG Antenna	CBL6111D	22263	Nov. 23, 2018	Nov. 22, 2019
Sonoma Preamplifier	310N	352922	Feb. 19, 2019	Feb. 18, 2020
ADT. Turn Table	TT100	0401	NA	NA
ADT. Tower	AT100	0401	NA	NA
Software	Radiated_V7.6.15.9.5	NA	NA	NA
ADT RF Switches BOX	EMH-011	08004	Mar. 26, 2019	Mar. 25, 2020
WOKEN RF cable With 5dB PAD	8D	CABLE-ST4-01	Mar. 26, 2019	Mar. 25, 2020

- Note:
1. The calibration interval of the above test instruments is 12 months and the calibrations are traceable to NML/ROC and NIST/USA.
 2. The test was performed in Open Site No. 4.
 3. The VCCI Site Registration No. R-11038.
 4. Tested Date: Jun. 18, 2019

6.3 Test Arrangement

- The EUT was placed on the top of a rotating table 0.8 meters above the ground at an accredited test facility. The table was rotated 360 degrees to determine the position of the highest radiation.
- The EUT was set 10 meters away from the interference-receiving antenna, which was mounted on the top of a variable-height antenna tower.
- The antenna is a broadband antenna, and its height is varied from one meter to four meters above the ground to determine the maximum value of the field strength. Both horizontal and vertical polarizations of the antenna are set to make the measurement.
- For each suspected emission, the EUT was arranged to its worst case and then the antenna was tuned to heights from 1 meter to 4 meters and the rotatable table was turned from 0 degrees to 360 degrees to find the maximum reading.
- The test-receiver system was set to quasi-peak detect function and specified bandwidth with maximum hold mode when the test frequency is up to 1 GHz.

Note: The resolution bandwidth and video bandwidth of test receiver/spectrum analyzer is 120kHz for quasi-peak detection (QP) at frequency up to 1GHz.

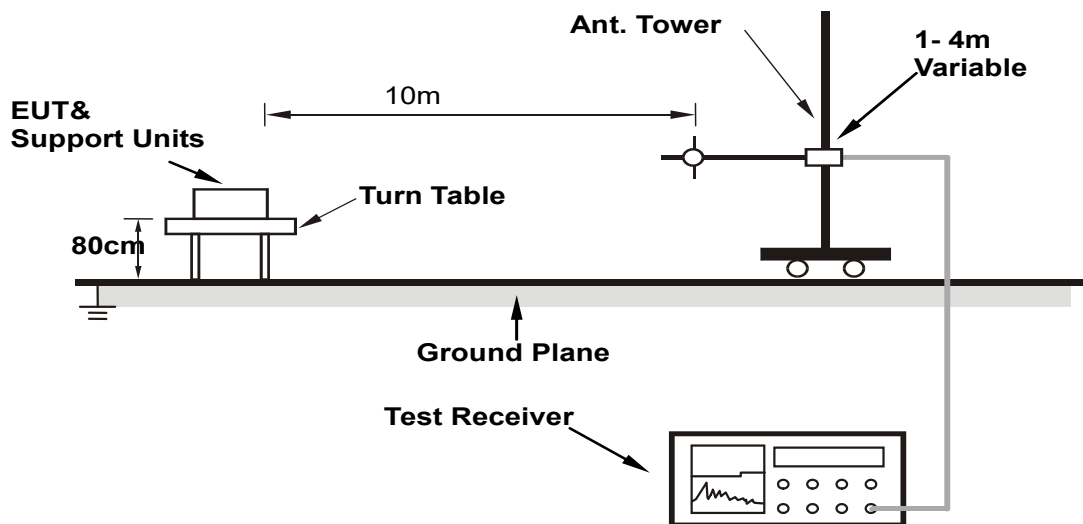

For the actual test configuration, please refer to the related item – Photographs of the Test Configuration.

6.4 Test Results

Frequency Range	30MHz ~ 1GHz	Detector Function & Bandwidth	Quasi-Peak (QP), 120kHz
Tested by	Adam Chen	Environmental Conditions	30°C, 61%RH
Test Mode	Mode 1		

Antenna Polarity & Test Distance : Horizontal at 10 m

No	Frequency (MHz)	Emission Level (dBuV/m)	Limit (dBuV/m)	Margin (dB)	Antenna Height (m)	Table Angle (Degree)	Raw Value (dBuV)	Correction Factor (dB/m)
1	58.79	29.23 QP	40.00	-10.77	4.00 H	108	49.08	-19.85
2	121.48	34.69 QP	40.00	-5.31	4.00 H	353	48.71	-14.02
3	143.32	30.79 QP	40.00	-9.21	4.00 H	73	44.74	-13.95
4	153.64	30.53 QP	40.00	-9.47	4.00 H	205	44.89	-14.36
5	168.43	29.59 QP	40.00	-10.41	4.00 H	149	44.82	-15.23
6	183.27	29.54 QP	40.00	-10.46	4.00 H	38	45.11	-15.57
7	225.02	31.28 QP	40.00	-8.72	4.00 H	219	45.86	-14.58
8	350.00	41.05 QP	47.00	-5.95	2.41 H	249	51.61	-10.56
9	375.01	39.13 QP	47.00	-7.87	2.13 H	229	49.11	-9.98
10	400.00	38.82 QP	47.00	-8.18	2.03 H	213	47.84	-9.02
11	425.02	39.08 QP	47.00	-7.92	2.06 H	267	47.23	-8.15
12	750.01	39.43 QP	47.00	-7.57	1.00 H	164	41.06	-1.63
13	999.99	39.97 QP	47.00	-7.03	1.00 H	236	36.33	3.64

Remarks:

1. Emission Level(dBuV/m) = Raw Value(dBuV) + Correction Factor(dB/m)
2. Correction Factor(dB/m) = Antenna Factor (dB/m) + Cable Factor (dB)
– Pre-Amplifier Factor (dB)
3. The other emission levels were very low against the limit.
4. Margin value = Emission level – Limit value

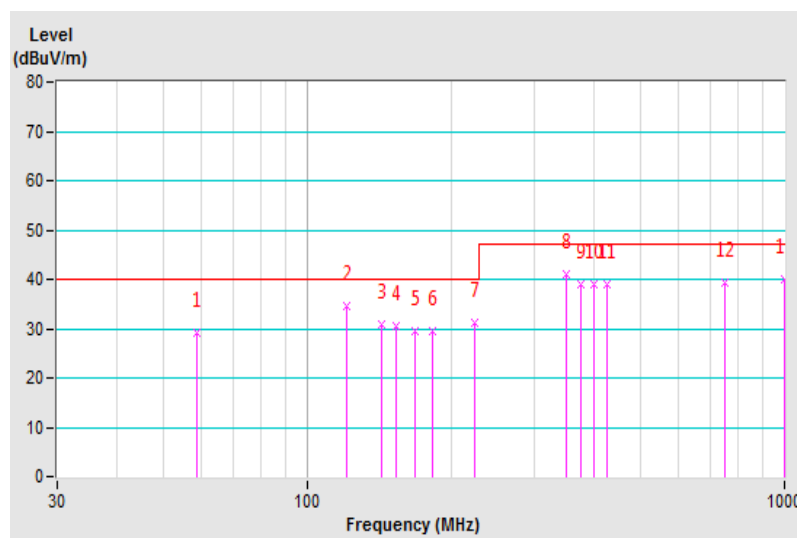

Frequency Range	30MHz ~ 1GHz	Detector Function & Bandwidth	Quasi-Peak (QP), 120kHz
Tested by	Adam Chen	Environmental Conditions	30°C, 61%RH
Test Mode	Mode 1		

Antenna Polarity & Test Distance : Vertical at 10 m								
No	Frequency (MHz)	Emission Level (dBuV/m)	Limit (dBuV/m)	Margin (dB)	Antenna Height (m)	Table Angle (Degree)	Raw Value (dBuV)	Correction Factor (dB/m)
1	31.42	31.35 QP	40.00	-8.65	1.28 V	221	40.07	-8.72
2	55.83	33.67 QP	40.00	-6.33	1.59 V	94	53.42	-19.75
3	86.98	32.49 QP	40.00	-7.51	1.67 V	176	49.72	-17.23
4	110.34	30.68 QP	40.00	-9.32	1.00 V	324	45.49	-14.81
5	121.98	34.42 QP	40.00	-5.58	1.00 V	119	48.45	-14.03
6	141.72	35.34 QP	40.00	-4.66	1.00 V	209	49.26	-13.92
7	166.91	31.98 QP	40.00	-8.02	1.00 V	138	47.08	-15.10
8	225.00	34.46 QP	40.00	-5.54	1.00 V	329	49.04	-14.58
9	375.01	38.70 QP	47.00	-8.30	1.00 V	122	48.68	-9.98
10	450.02	36.25 QP	47.00	-10.75	1.00 V	257	44.10	-7.85
11	750.01	39.28 QP	47.00	-7.72	2.65 V	201	40.91	-1.63
12	999.98	42.15 QP	47.00	-4.85	1.98 V	23	38.51	3.64

Remarks:

1. Emission Level(dBuV/m) = Raw Value(dBuV) + Correction Factor(dB/m)
2. Correction Factor(dB/m) = Antenna Factor (dB/m) + Cable Factor (dB) – Pre-Amplifier Factor (dB)
3. The other emission levels were very low against the limit.
4. Margin value = Emission level – Limit value

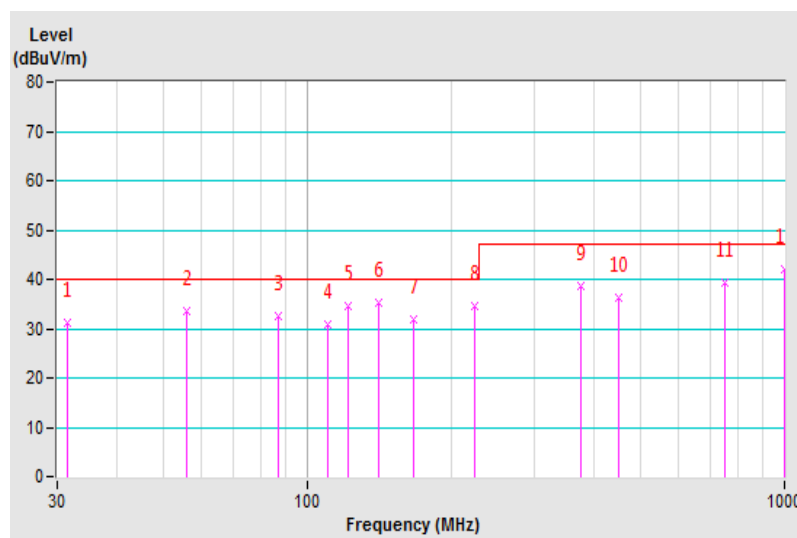

7 Radiated Disturbance above 1 GHz

7.1 Limits

Frequency (GHz)	dBuV/m (at 3m)	
	Average	Peak
1 to 3	56	76
3 to 6	60	80

- Notes: 1. The lower limit shall apply at the transition frequencies.
 2. Emission level (dBuV/m) = 20 log Emission level (uV/m).
 3. All emanations from a class A/B digital device or system, including any network of conductors and apparatus connected thereto, shall not exceed the level of field strengths specified above.

Frequency Range (For unintentional radiators)

Highest frequency generated or used in the EUT or on which the EUT operates or tunes (MHz)	Upper frequency of measurement range (MHz)
Below 108	1000
108-500	2000
500-1000	5000
Above 1000	Up to 5 times of the highest frequency or 6 GHz, whichever is less

7.2 Test Instruments

Description & Manufacturer	Model No.	Serial No.	Cal. Date	Cal. Due
Agilent Spectrum	E4446A	MY51100009	Jun. 6, 2019	Jun. 5, 2020
Agilent Test Receiver	N9038A	MY50010135	May 29, 2019	May 28, 2020
Agilent Preamplifier	8449B	3008A01924	Feb. 21, 2019	Feb. 20, 2020
MITEQ Preamplifier	AMF-6F-260400-33-8P	892164	Feb. 21, 2019	Feb. 20, 2020
EMCI Preamplifier	EMC184045B	980235	Feb. 21, 2019	Feb. 20, 2020
ETS Preamplifier	3117-PA	00215857	Nov. 25, 2018	Nov. 24, 2019
Schwarzbeck Horn Antenna	BBHA-9170	212	Nov. 25, 2018	Nov. 24, 2019
EMCO Horn Antenna	3115	9312-4192	Nov. 25, 2018	Nov. 24, 2019
Max Full. Turn Table & Tower	MF7802	MF780208103	NA	NA
Software	Radiated_V8.7.08	NA	NA	NA
SUHNER RF cable With 4dB PAD	SF106-18	Cable-CH7-01	Aug. 13, 2018	Aug. 12, 2019
SUHNER RF cable With 3/4dB PAD	SF102	Cable-CH7-3.6m	Aug. 13, 2018	Aug. 12, 2019
MICRO-TRONICS Notch filter	BRC50703-01	010	May 30, 2019	May 29, 2020
MICRO-TRONICS Band Pass Filter	BRM17690	005	May 30, 2019	May 29, 2020

- Note:
1. The calibration interval of the above test instruments is 12 months and the calibrations are traceable to NML/ROC and NIST/USA.
 2. The test was performed in Chamber No. 7.
 3. The VCCI Site Registration No. G-10039
 4. Tested Date: Jun. 19, 2019

7.3 Test Arrangement

- The EUT was placed on the top of a rotating table 0.8 meters above the ground at an accredited chamber room. The table was rotated 360 degrees to determine the position of the highest radiation.
- The EUT was set 3 meters away from the interference-receiving antenna, which was mounted on the top of a variable-height antenna tower.
- The height of antenna can be varied from one meter to four meters, the height of adjustment depends on the EUT height and the antenna 3dB beamwidth both, to detect the maximum value of the field strength. Both horizontal and vertical polarizations of the antenna are set to make the measurement.
- For each suspected emission, the EUT was arranged to its worst case and then the antenna was tuned to heights and the rotatable table was turned from 0 degrees to 360 degrees to find the maximum reading.
- The spectrum analyzer system was set to peak and average detect function and specified bandwidth with maximum hold mode when the test frequency is above 1 GHz.

Note: The resolution bandwidth of test receiver/spectrum analyzer is 1MHz and video bandwidth is 3MHz for Peak detection (PK) at frequency above 1GHz. The resolution bandwidth of test receiver/spectrum analyzer is 1 MHz for Average detection (AV) at frequency above 1GHz.

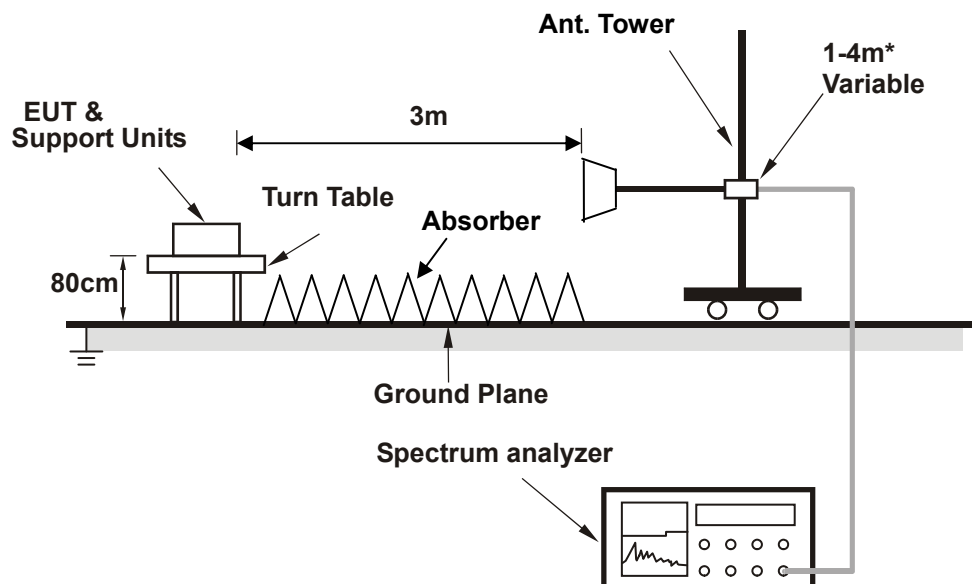

* :depends on the EUT height and the antenna 3dB beamwidth both.

For the actual test configuration, please refer to the related item – Photographs of the Test Configuration.

7.4 Test Results

Frequency Range	1GHz ~ 5GHz	Detector Function & Bandwidth	Peak (PK) / Average (AV), 1MHz
Tested by	Chenghan Wu	Environmental Conditions	28°C, 78%RH
Test Mode	Mode 1		

Antenna Polarity & Test Distance : Horizontal at 3 m								
No	Frequency (MHz)	Emission Level (dBuV/m)	Limit (dBuV/m)	Margin (dB)	Antenna Height (m)	Table Angle (Degree)	Raw Value (dBuV)	Correction Factor (dB/m)
1	1000.06	47.55 PK	70.00	-22.45	1.25 H	141	54.61	-7.06
2	1000.06	46.01 AV	50.00	-3.99	1.25 H	141	53.07	-7.06
3	1318.03	48.64 PK	70.00	-21.36	1.30 H	113	54.43	-5.79
4	1318.03	29.78 AV	50.00	-20.22	1.30 H	113	35.57	-5.79
5	1418.14	44.65 PK	70.00	-25.35	1.49 H	200	50.64	-5.99
6	1418.14	27.93 AV	50.00	-22.07	1.49 H	200	33.92	-5.99
7	1499.94	44.41 PK	70.00	-25.59	1.33 H	171	50.25	-5.84
8	1499.94	40.09 AV	50.00	-9.91	1.33 H	171	45.93	-5.84
9	2842.88	46.57 PK	70.00	-23.43	2.18 H	69	48.22	-1.65
10	2842.88	30.70 AV	50.00	-19.30	2.18 H	69	32.35	-1.65
11	2944.21	58.15 PK	70.00	-11.85	2.36 H	100	58.90	-0.75
12	2944.21	41.55 AV	50.00	-8.45	2.36 H	100	42.30	-0.75

Remarks:

1. Emission Level(dBuV/m) = Raw Value(dBuV) + Correction Factor(dB/m)
2. Correction Factor(dB/m) = Antenna Factor (dB/m) + Cable Factor (dB) – Pre-Amplifier Factor (dB)
3. The other emission levels were very low against the limit.
4. Margin value = Emission level – Limit value

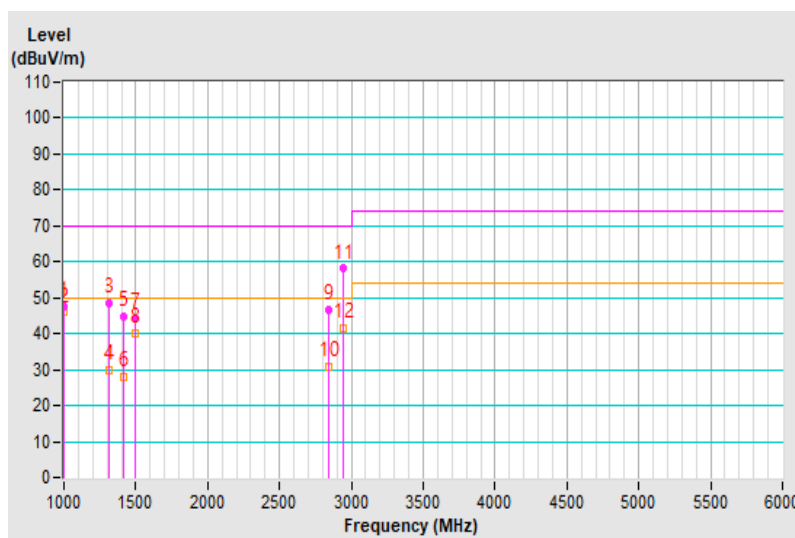

Frequency Range	1GHz ~ 5GHz	Detector Function & Bandwidth	Peak (PK) / Average (AV), 1MHz
Tested by	Chenghan Wu	Environmental Conditions	28°C, 78%RH
Test Mode	Mode 1		

Antenna Polarity & Test Distance : Vertical at 3 m								
No	Frequency (MHz)	Emission Level (dBuV/m)	Limit (dBuV/m)	Margin (dB)	Antenna Height (m)	Table Angle (Degree)	Raw Value (dBuV)	Correction Factor (dB/m)
1	1000.08	50.25 PK	70.00	-19.75	1.15 V	179	57.31	-7.06
2	1000.08	46.89 AV	50.00	-3.11	1.15 V	179	53.95	-7.06
3	1303.99	51.44 PK	70.00	-18.56	1.45 V	120	57.17	-5.73
4	1303.99	32.44 AV	50.00	-17.56	1.45 V	119	38.17	-5.73
5	1893.66	49.75 PK	70.00	-20.25	1.81 V	119	53.64	-3.89
6	1893.66	31.14 AV	50.00	-18.86	1.81 V	119	35.03	-3.89
7	2128.68	47.05 PK	70.00	-22.95	1.13 V	226	50.44	-3.39
8	2128.68	29.96 AV	50.00	-20.04	1.13 V	226	33.35	-3.39
9	2477.84	47.47 PK	70.00	-22.53	1.67 V	181	50.14	-2.67
10	2477.84	29.93 AV	50.00	-20.07	1.67 V	181	32.60	-2.67
11	2939.32	59.28 PK	70.00	-10.72	2.10 V	146	60.08	-0.80
12	2939.32	42.03 AV	50.00	-7.97	2.10 V	146	42.83	-0.80

Remarks:

1. Emission Level(dBuV/m) = Raw Value(dBuV) + Correction Factor(dB/m)
2. Correction Factor(dB/m) = Antenna Factor (dB/m) + Cable Factor (dB) – Pre-Amplifier Factor (dB)
3. The other emission levels were very low against the limit.
4. Margin value = Emission level – Limit value

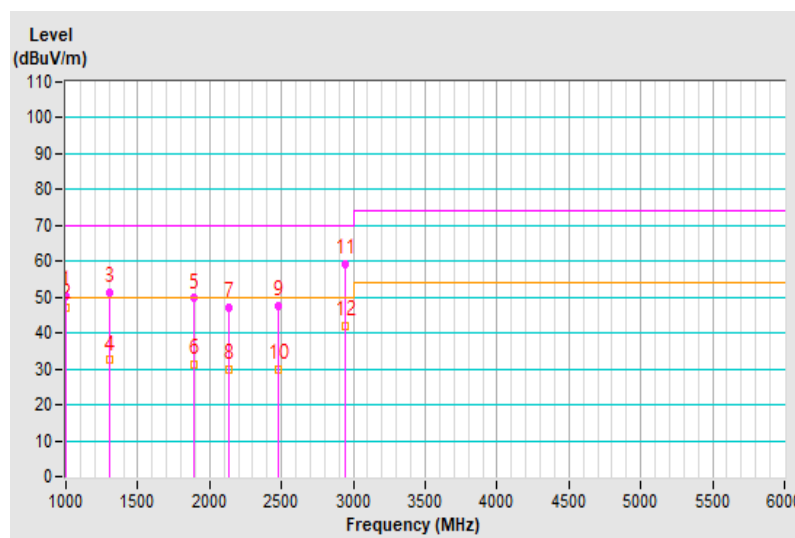

8 Electrostatic Discharge Immunity Test (ESD)

8.1 Test Specification

Basic Standard:	EN 61000-4-2
Discharge Impedance:	330 ohm / 150 pF
Discharge Voltage:	Air Discharge: $\pm 2, \pm 4, \pm 8$ kV (Direct) Contact Discharge: $\pm 2, \pm 4$ kV, ± 6 kV (Direct/Indirect)
Number of Discharge:	Minimum 20 times at each test point
Discharge Mode:	Single Discharge
Discharge Period:	1-second minimum

8.2 Test Instruments

Description & Manufacturer	Model No.	Serial No.	Cal. Date	Cal. Due
KeyTek, ESD Simulator	MZ-15/EC	0504259	Nov. 12, 2018	Nov. 11, 2019

- Note:
1. The calibration interval of the above test instruments is 12 months and the calibrations are traceable to NML/ROC and NIST/USA.
 2. The test was performed in ESD Room No. 1.
 3. Tested Date: Jun. 22, 2019

8.3 Test Arrangement

- a. Electrostatic discharges were applied only to those points and surfaces of the EUT that are accessible to users during normal operation.
- b. The test was performed with at least ten single discharges on the pre-selected points in the most sensitive polarity.
- c. The time interval between two successive single discharges was at least 1 second.
- d. The ESD generator was held perpendicularly to the surface to which the discharge was applied and the return cable was at least 0.2 meters from the EUT.
- e. Contact discharges were applied to the non-insulating coating, with the pointed tip of the generator penetrating the coating and contacting the conducting substrate.
- f. Air discharges were applied with the round discharge tip of the discharge electrode approaching the EUT as fast as possible (without causing mechanical damage) to touch the EUT. After each discharge, the ESD generator was removed from the EUT and re-triggered for a new single discharge. The test was repeated until all discharges were complete.
- g. At least ten single discharges (in the most sensitive polarity) were applied to the **Horizontal Coupling Plane** at points on each side of the EUT. The ESD generator was positioned at a distance of 0.1 meters from the EUT with the discharge electrode touching the **HCP**.
- h. At least ten single discharges (in the most sensitive polarity) were applied to the center of one vertical edge of the **Vertical Coupling Plane** in sufficiently different positions that the four faces of the EUT were completely illuminated. The **VCP** (dimensions 0.5m x 0.5m) was placed vertically to and 0.1 meters from the EUT.

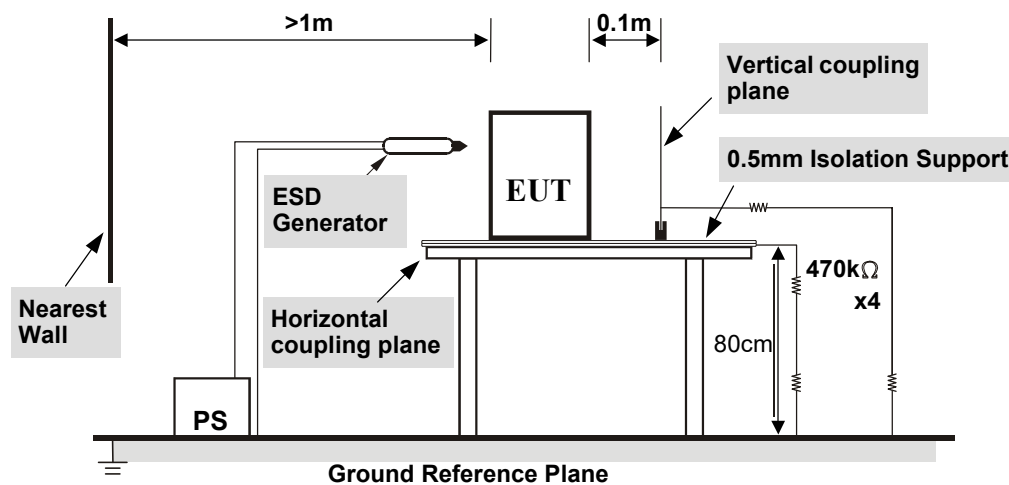

TABLE-TOP EQUIPMENT

The configuration consisted of a wooden table 0.8 meters high standing on the **Ground Reference Plane**. The **GRP** consisted of a sheet of aluminum at least 0.25mm thick, and 2.5 meters square connected to the protective grounding system. A **Horizontal Coupling Plane** (1.6m x 0.8m) was placed on the table and attached to the **GRP** by means of a cable with 940kΩ total impedance. The equipment under test, was installed in a representative system as described in section 7 of EN 61000-4-2, and its cables were placed on the **HCP** and isolated by an insulating support of 0.5mm thickness. A distance of 1-meter minimum was provided between the EUT and the walls of the laboratory and any other metallic structure.

For the actual test configuration, please refer to the related item – Photographs of the Test Configuration.

8.4 Test Results

Input Power (System)	230 Vac, 50 Hz	Tested by	Todd Chang
Environmental Conditions	25 °C, 39% RH 1001 mbar	Test mode	Mode 1

Test Results of Direct Application

Discharge Level (kV)	Polarity (+/-)	Test Point	Contact Discharge	Air Discharge	Performance Criterion
2, 4, 6	+/-	1, 2	Note	NA	A
2, 4, 8	+/-	3	NA	Note	A

Description of test points of direct application: Please refer to following page for representative mark only.

Test Results of Indirect Application

Discharge Level (kV)	Polarity (+/-)	Test Point	Horizontal Coupling Plane	Vertical Coupling Plane	Performance Criterion
2, 4, 6	+/-	Four Sides	Note	Note	A

Description of test points of indirect application:

1. Front side 2. Rear side 3. Right side 4. Left side

Note: The EUT function was correct during the test.

Description of Test Points

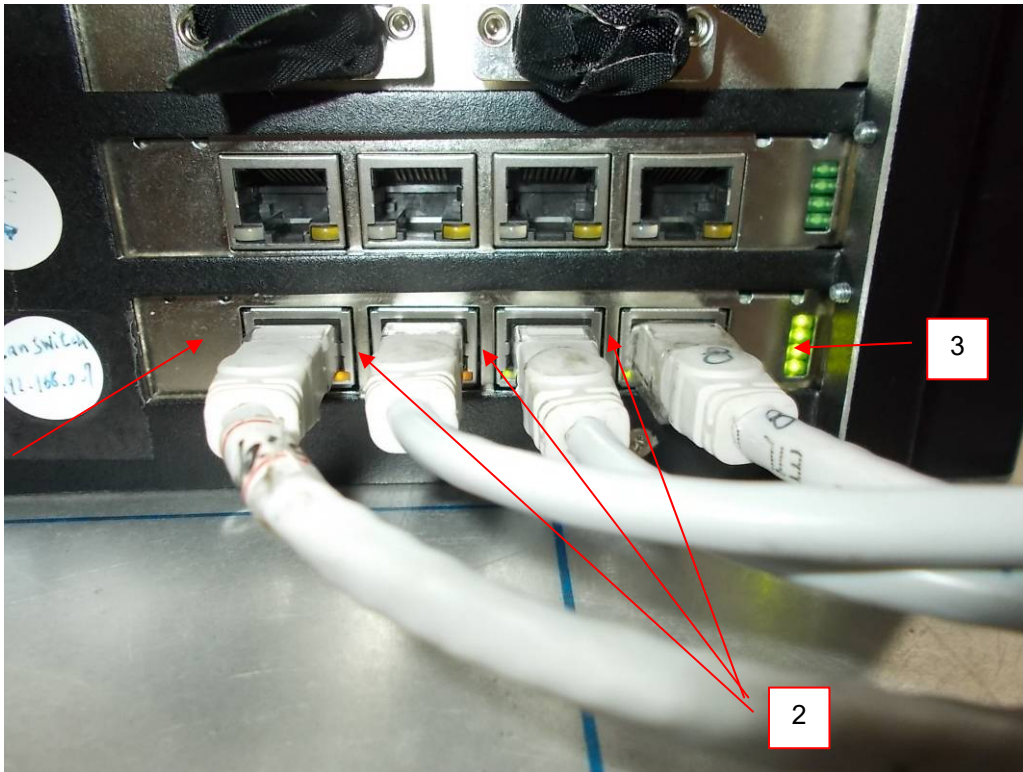

9 Radio-frequency Electromagnetic Field Immunity Test (RS)

9.1 Test Specification

Basic Standard:	EN 61000-4-3
Frequency Range, Field Strength:	80-800 MHz, 20V/m ¹
	800-1000 MHz, 20V/m
	1400-2000 MHz, 10V/m
	2000-2700 MHz, 5V/m
Modulation:	5100-6000 MHz, 3V/m
	1kHz Sine Wave, 80%, AM Modulation
Frequency Step:	1 % of preceding frequency value
Polarity of Antenna:	Horizontal and Vertical
Antenna Height:	1.55m
Dwell Time:	3 seconds

Note 1: This limit applies to equipment mounted in the passenger compartments, drivers cab or external to the rolling stock (roof, underframe). For equipment mounted in all other areas a severity level of 10 V/m may be used.

9.2 Test Instruments

Description & Manufacturer	Model No.	Serial No.	Cal. Date	Cal. Due
BONN Power Amp	BLMA 1060-100/50D	118694	NA	NA
BBA Power Amp	B250C125	101011	NA	NA
Power Sensor	NRP-Z91	101572	Jan. 24, 2019	Jan. 23, 2020
Power Sensor	NRP-Z91	101573	Jan. 18, 2019	Jan. 17, 2020
Signal Generator	SMB100A	105801	Jan. 17, 2019	Jan. 16, 2020
R&S Software	EMC32 Version 8.52.0	NA	NA	NA
Stacked Log-Per Antenna	STLP9149	9149-141	NA	NA
High GAIN LOG-Periodic Antenna	HL046E	100114	NA	NA

- Note:
1. The test was performed in Hwa Ya RS Room 2.
 2. The calibration interval of the above test instruments is 12 months and the calibrations are traceable to NML/ROC and NIST/USA.
 3. The transmit antenna was located at a distance of 3 meters from the EUT.
 4. Tested Date: Aug. 24, 2019

3.

9.3 Test Arrangement

The test procedure was in accordance with EN 61000-4-3.

- a. The testing was performed in a fully anechoic chamber.
- b. The frequency ranges and field strength levels are 80-800 MHz, 20V/m, 800-1000 MHz, 20V/m, 1400-2000 MHz, 10V/m, 2000-2700 MHz, 5V/m and 5100-6000 MHz, 3V/m with the signal 80% amplitude modulated with a 1kHz sine wave.
- c. The test was performed with the EUT exposed to both vertically and horizontally polarized fields on each of the four sides.

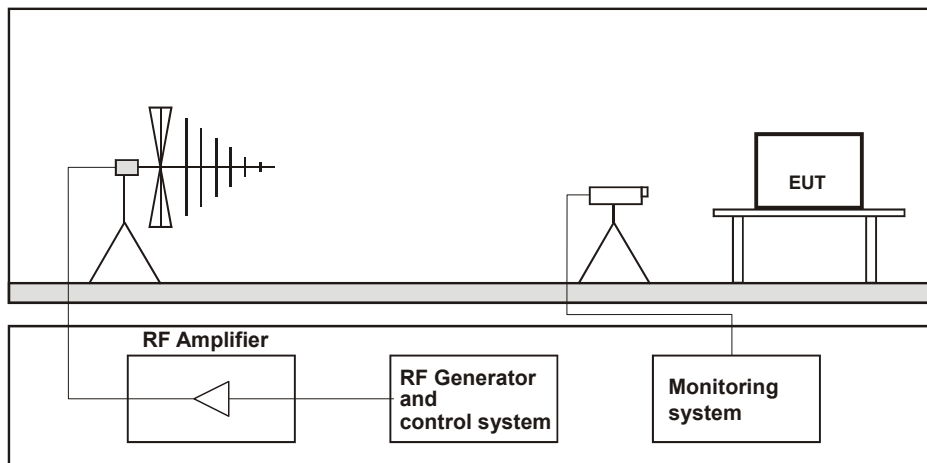

Table-top Equipment

The EUT installed in a representative system as described in section 7 of EN 61000-4-3 was placed on a non-conductive table 0.8 meters in height. The system under test was connected to the power and signal wire according to relevant installation instructions.

For the actual test configuration, please refer to the related item – Photographs of the Test Configuration.

9.4 Test Results

Input Power	24 Vdc	Tested by	Matt Lan
Environmental Conditions	23 °C, 58% RH	Test mode	Mode 1

Frequency (MHz)	Polarity	Azimuth(°)	Applied Field Strength		Observation	Test Distance (m)	Performance Criterion
			(V/m)	Modulation			
80 - 800	V&H	0, 90, 180, 270	20	80% AM (1kHz)	Note	3	A
800 - 1000	V&H	0, 90, 180, 270	20	80% AM (1kHz)	Note	3	A
1400 - 2000	V&H	0, 90, 180, 270	10	80% AM (1kHz)	Note	3	A
2000 - 2700	V&H	0, 90, 180, 270	5	80% AM (1kHz)	Note	3	A
5100 - 6000	V&H	0, 90, 180, 270	3	80% AM (1kHz)	Note	3	A

Note: The EUT function was correct during the test.

10 Electrical Fast Transient/Burst Immunity Test (EFT)

10.1 Test Specification

Basic Standard:	EN 61000-4-4
Test Voltage:	Signal & communication, process measurement & control ports: ± 2 kV, Capacitive clamp Battery referenced ports (except at the output of energy sources), Auxiliary a.c. power input ports (rated voltage ≤ 400 Vrms): N/A
Impulse Repetition Frequency:	5kHz
Impulse Wave Shape:	5/50 (T_r/T_h) ns
Burst Duration:	15 ms
Burst Period:	300 ms
Test Duration:	1 min.

10.2 Test Instruments

Description & Manufacturer	Model No.	Serial No.	Cal. Date	Cal. Due
Haefely, EFT Generator	PEFT 4010	154954	Apr. 23, 2019	Apr. 22, 2020
Haefely, Capacitive Clamp	IP4A	155173	Apr. 23, 2019	Apr. 22, 2020

- Note:
1. The calibration interval of the above test instruments is 12 months and the calibrations are traceable to NML/ROC and NIST/USA.
 2. The test was performed in EFT Room.
 3. Tested Date: Jun. 26, 2019

10.3 Test Arrangement

- Both positive and negative polarity discharges were applied.
- The distance between any coupling devices and the EUT should be 0.5 m for table-top equipment testing, and 1.0 m for floor standing equipment.
- The duration time of each test sequential was 1 minute.
- The transient/burst waveform was in accordance with EN 61000-4-4, 5/50 ns.

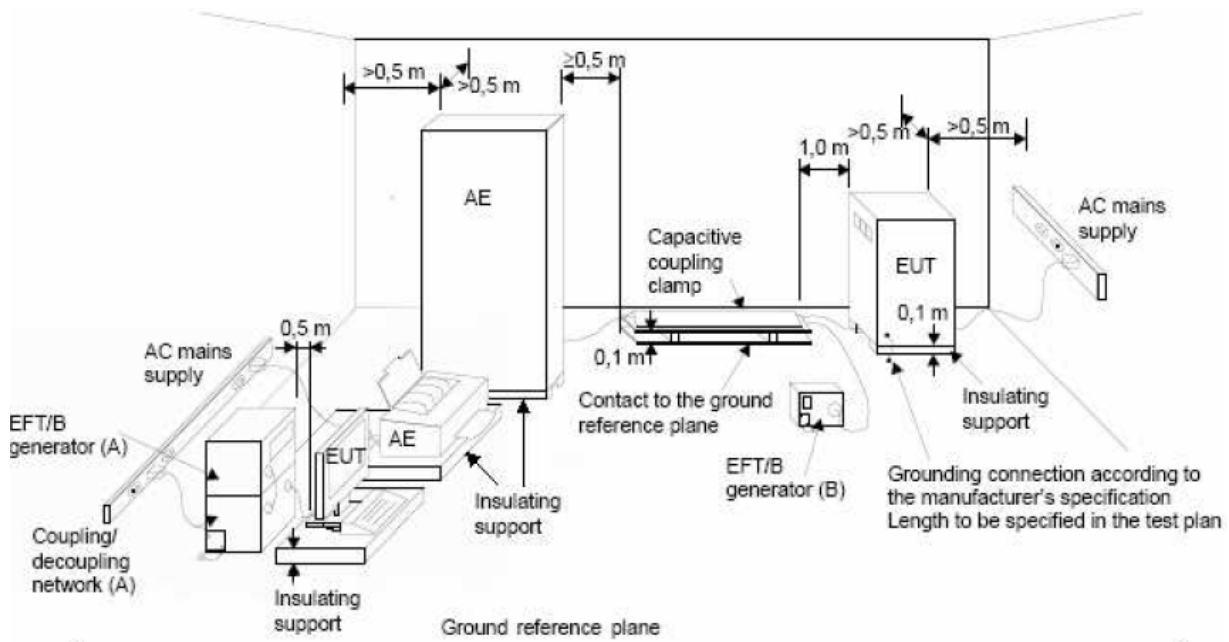

NOTE:

- location for supply line coupling
- location for signal lines coupling

For the actual test configuration, please refer to the related item – Photographs of the Test Configuration.

10.4 Test Results

Input Power (System)	230 Vac, 50 Hz	Tested by	Josh Lin
Environmental Conditions	24°C, 76% RH	Test mode	Mode 1

Signal & communication, process measurement & control ports

Voltage (kV)	Test Point	Polarity (+/-)	Observation	Performance Criterion
2	RJ 45 (PoE)	+/-	Note	A

Note: The EUT function was correct during the test.

11 Immunity to Conducted Disturbances Induced by RF Fields (CS)

11.1 Test Specification

Basic Standard:	EN 61000-4-6
Frequency Range:	0.15 MHz - 80 MHz
Voltage Level:	Battery referenced ports (except at the output of energy sources), Auxiliary a.c. power input ports (rated voltage \leq 400 Vrms), Signal & communication, process measurement & control ports: 10 V
Modulation:	1kHz Sine Wave, 80%, AM Modulation
Frequency Step:	1 % of preceding frequency value
Dwell Time	3 seconds

11.2 Test Instruments

Description & Manufacturer	Model No.	Serial No.	Cal. Date	Cal. Due
ROHDE & SCHWARZ Signal Generator	SML03	101801	Jan. 14, 2019	Jan. 13, 2020
Digital Sweep Function Generator	8120	984801	NA	NA
AR Power Amplifier	75A250AM1	306331	NA	NA
FCC Coupling Decoupling Network	FCC-801-M2-16A	01047	Jun. 19, 2019	Jun. 18, 2020
FISCHER CUSTOM COMMUNICATIONS EM Injection Clamp	F-203I-23mm	455	NA	NA
FISCHER CUSTOM COMMUNICATIONS Current Injection Clamp	F-120-9A	361	Jul. 24, 2018	Jul. 23, 2019
B&K Ear Simulator	4185	2553594	NA	NA
EM TEST Coupling Decoupling Network	CDN M1/32A	306508	Jun. 19, 2019	Jun. 18, 2020
TESEQ Coupling Decoupling Network	CDN T800	34428	Jun. 19, 2019	Jun. 18, 2020
TESEQ Coupling Decoupling Network	CDN T800	29459	Jun. 19, 2019	Jun. 18, 2020
FCC Coupling Decoupling Network	FCC-801-T4	02031	Jun. 19, 2019	Jun. 18, 2020
EM TEST Coupling Decoupling Network	CDN T2	306509	Jun. 19, 2019	Jun. 18, 2020
R&S Power Sensor	NRV-Z5	837878/039	Nov. 10, 2018	Nov. 9, 2019
R&S Power Meter	NRVD	837794/040	Nov. 10, 2018	Nov. 9, 2019
TESEQ Coupling Decoupling Network	CDN M232	37702	Jun. 19, 2019	Jun. 18, 2020
TESEQ Coupling Decoupling Network	CDN M332	41258	Jun. 19, 2019	Jun. 18, 2020
TESEQ Coupling Decoupling Network	CDN M332	41256	Jun. 19, 2019	Jun. 18, 2020
TESEQ Coupling Decoupling Network	CDN T400A	28569	Jun. 19, 2019	Jun. 18, 2020
TESEQ Coupling Decoupling Network	CDN T8-10	40376	Jun. 19, 2019	Jun. 18, 2020
TESEQ Coupling Decoupling Network	ISN ST08	41212	Jun. 19, 2019	Jun. 18, 2020
FCC Coupling Decoupling Network	FCC-801-M5-50A	100018	Jan. 21, 2019	Jan. 20, 2020
Software	CS_V7.4.2	NA	NA	NA

- Note:
1. The calibration interval of the above test instruments is 12 months and the calibrations are traceable to NML/ROC and NIST/USA.
 2. The test was performed in CS Room No. 1.
 3. Tested Date: Jun. 21, 2019

11.4 Test Results

Input Power (System)	230 Vac, 50 Hz	Tested by	Todd Chang
Environmental Conditions	25 °C, 63% RH	Test mode	Mode 1

Frequency (MHz)	Level (V rms)	Tested Line	Injection Method	Return Path	Observation	Remark	Performance Criterion
0.15 – 80	10	RJ45 (PoE)	CDN-T8-10	CDN-M3	Note	-	A

Note: The EUT function was correct during the test.

12 Pictures of Test Arrangements

12.1 Conducted Disturbance at Auxiliary a.c. or d.c. power ports

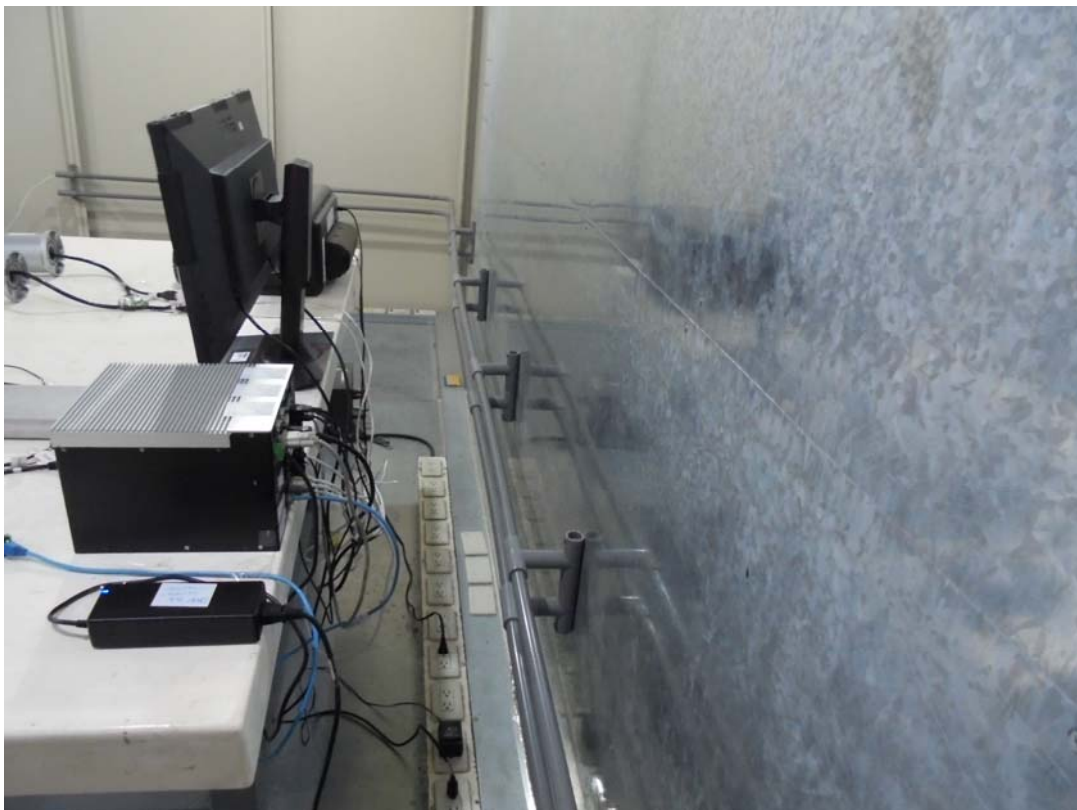

12.2 Radiated Disturbance up to 1 GHz



12.3 Radiated Disturbance above 1 GHz



12.4 Electrostatic Discharge Immunity Test (ESD)



12.5 Radio-frequency Electromagnetic Field Immunity Test (RS)

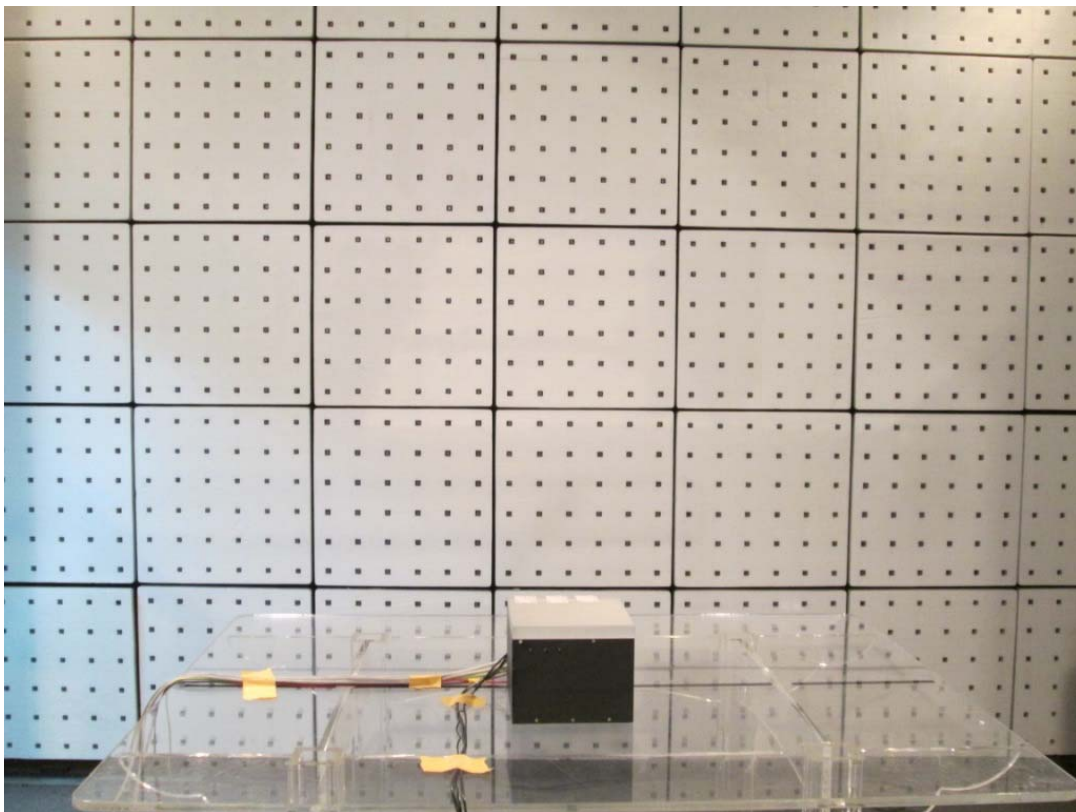
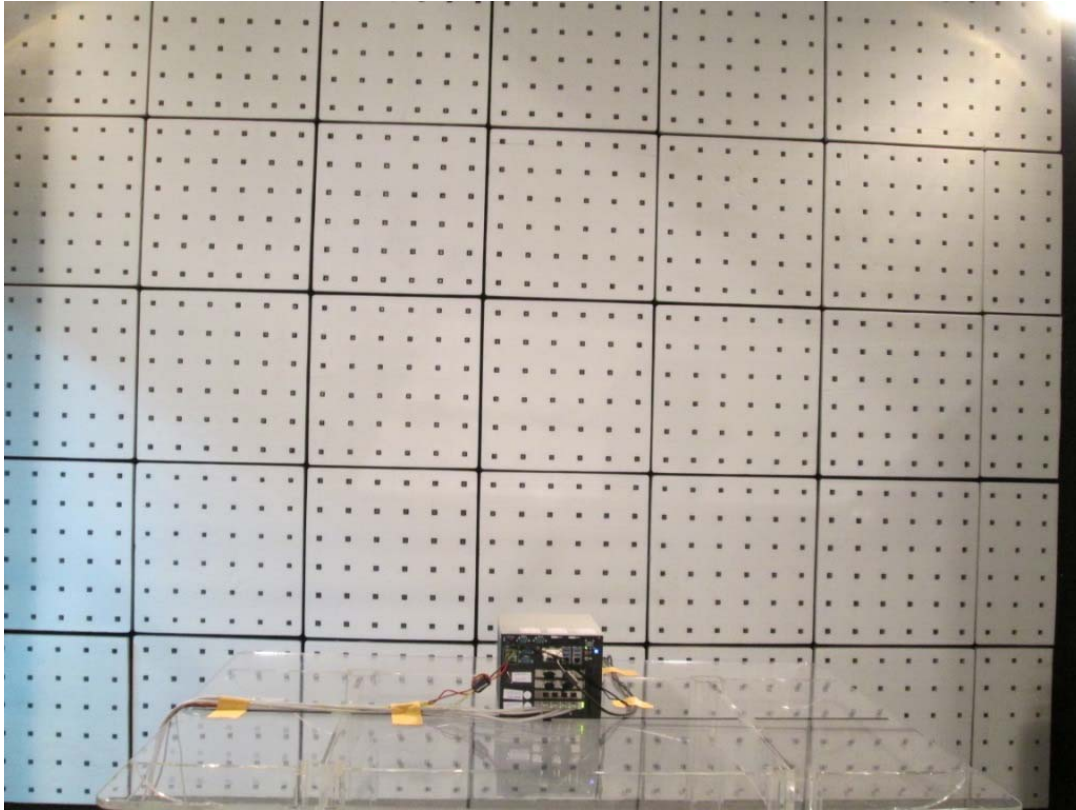

12.6 Fast Transients (EFT)

LAN ports



12.7 Radio-frequency common mode (CS)

LAN ports



Appendix – Information of the Testing Laboratories

We, Bureau Veritas Consumer Products Services (H.K.) Ltd., Taoyuan Branch, were founded in 1988 to provide our best service in EMC, Radio, Telecom and Safety consultation. Our laboratories are accredited and approved according to ISO/IEC 17025.

If you have any comments, please feel free to contact us at the following:

Lin Kou EMC/RF Lab

Tel: 886-2-26052180

Fax: 886-2-26051924

Hsin Chu EMC/RF/Telecom Lab

Tel: 886-3-6668565

Fax: 886-3-6668323

Hwa Ya EMC/RF/Safety Lab

Tel: 886-3-3183232

Fax: 886-3-3270892

Email: service.adt@tw.bureauveritas.com

Web Site: www.bureauveritas-adt.com

The address and road map of all our labs can be found in our web site also.

--- END ---